



ACBAR Eccentric reducers

AKIM gear technology – Swiss Made.

ACBAR Eccentric reducers.

ACBAR eccentric reducers are modularly built. The symmetric, compact and coaxial design allows to achieve greatest ratios on minimal space. The reducers are assembled with a minimum of moving parts, have lifetime lubrication and therefore completely maintenance free.

General informations.

- Modularly construction
- Symmetric, compact, coaxial design
- Special designs and special executions are possible (on request)
- Small to largest ratios with minimal space requirement
- Drive speed: 1500 min⁻¹ up to max. 6000 min⁻¹
- Ratios up to 13'600 : 1, single stage
- Available with low backlash
- Compatible with IEC motors
- Suitable with motors with standard flange B5 or B14
(normal shaft end, normal concentricity, without any additional shaft seal)
- Installation: horizontal or vertical
- All the moving parts rotate on roller bearings
- Minimum of moving parts
- All-round sealing
- Lifetime lubrication
- No oil fittings
- Maintenance free

Available in 6 different types.

- **Type 11** – for 80 Nm
- **Type 81** – for 150 Nm
- **Type 121** – for 250 Nm
- **Type 12/451** – for 450 Nm
- **Type 251** – for 600 Nm
- **Type 501** – for 1000 Nm

Please check our diagrams and tables or contact us. We will be happy to advise you.

Performance characteristics Type 11 (80Nm) and Type 81 (150Nm).

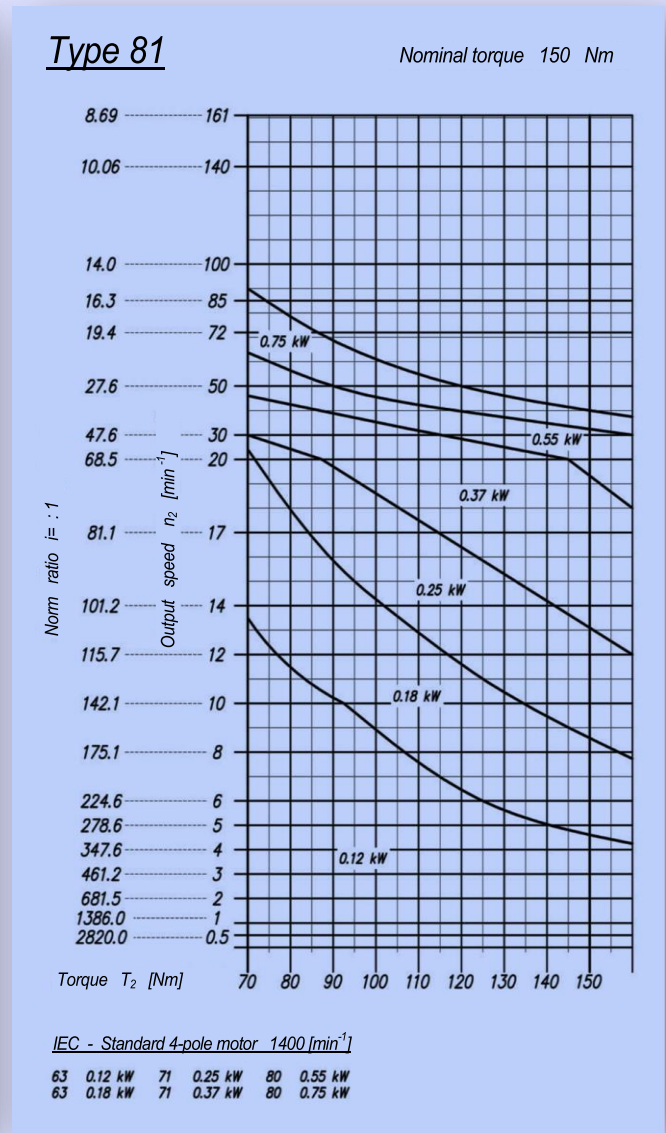
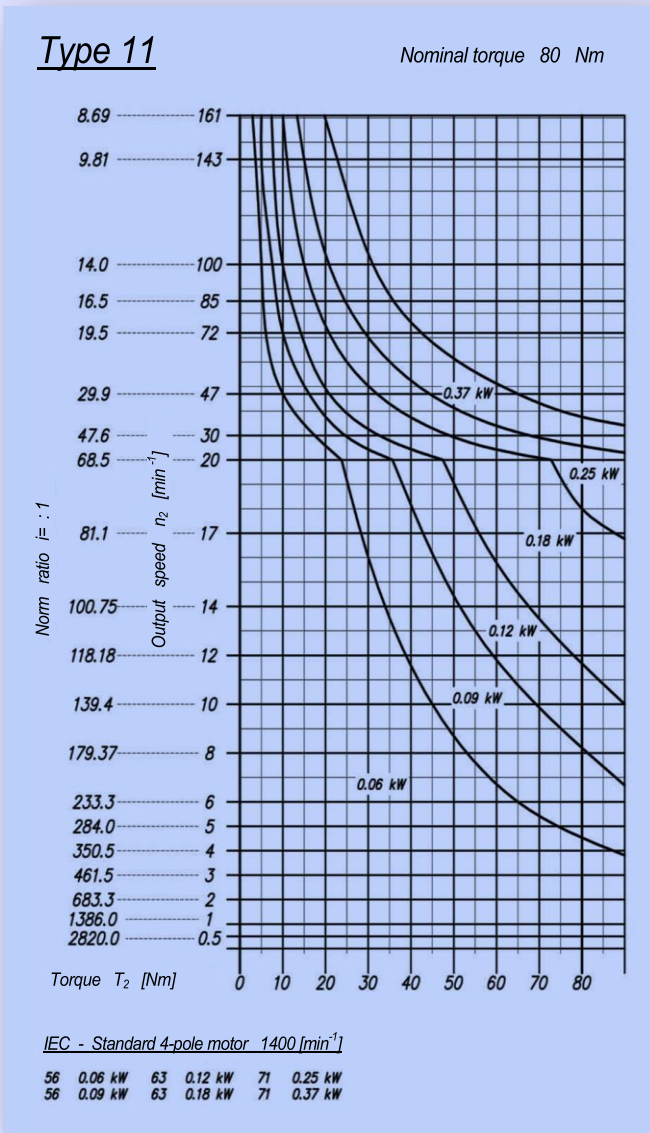

Performance characteristics Type 121 (250Nm) and Type 12/451 (450Nm).

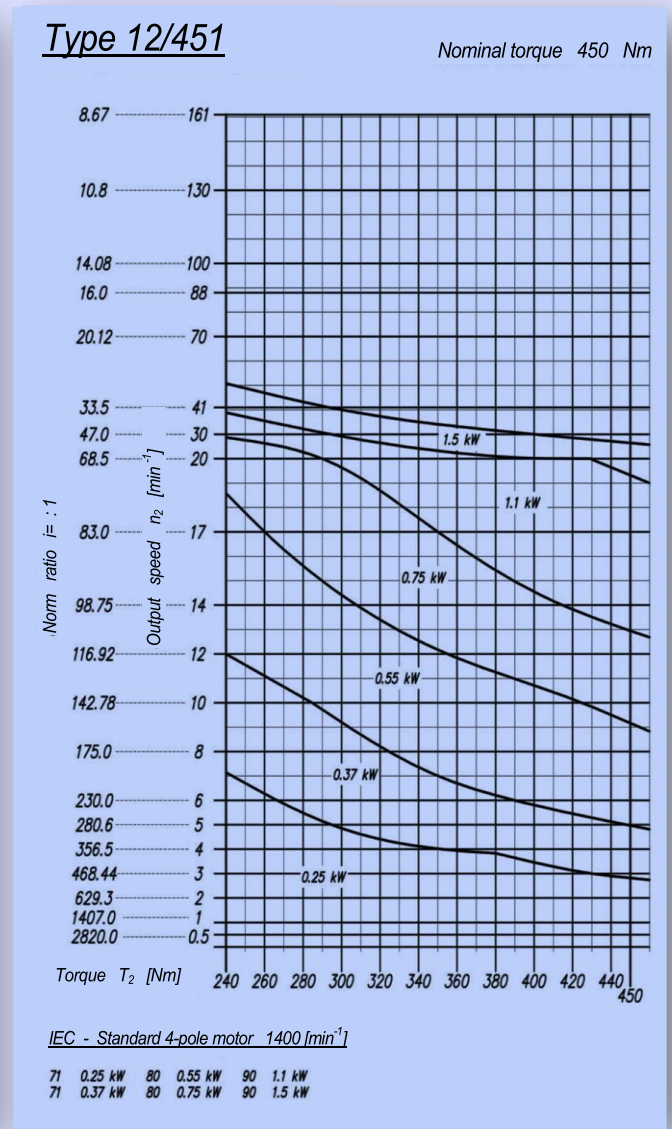
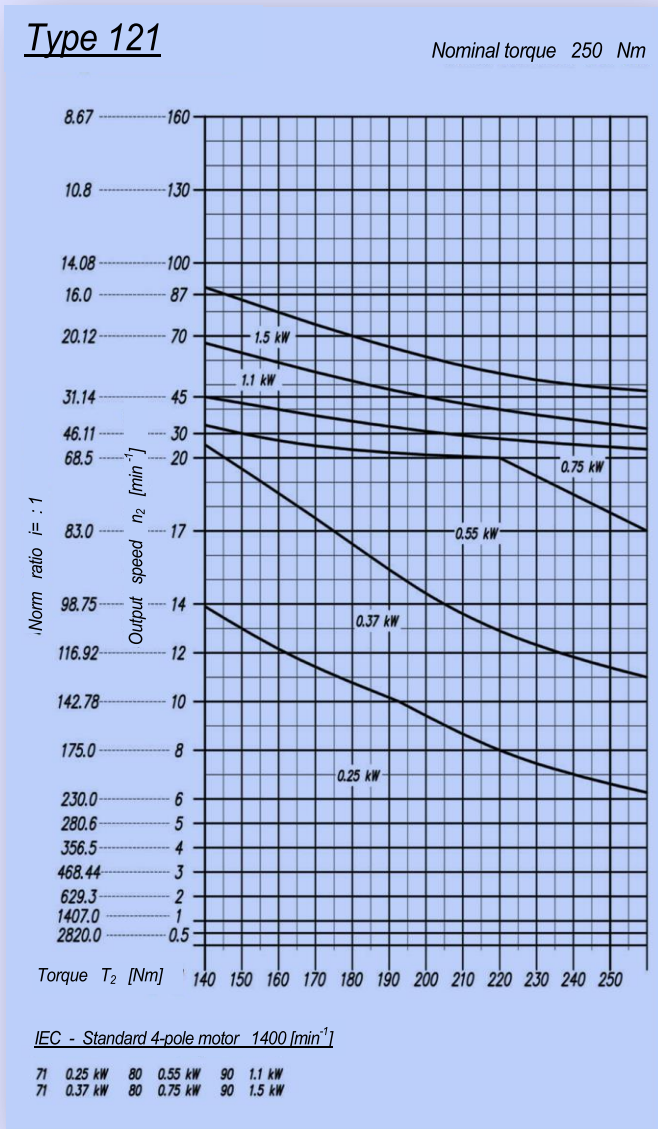

Performance characteristics Type 251 (600Nm) and Type 501 (1000Nm).

Type 251

Nominal torque 600 Nm

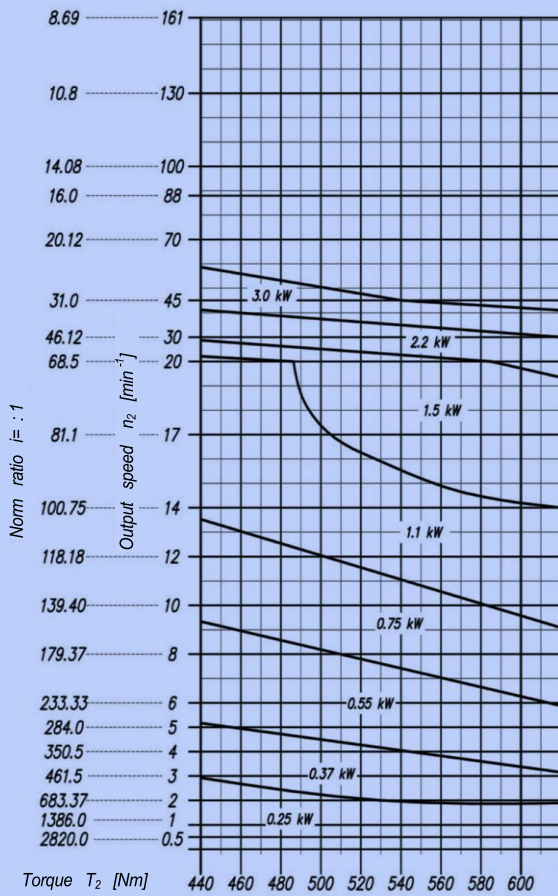

IEC - Standard 4-pole motor 1400 [min⁻¹]

71	0.25 kW	80	0.55 kW	90	1.1 kW	100	2.2 kW
71	0.37 kW	80	0.75 kW	90	1.5 kW	100	3.0 kW

Type 501

Nominal torque 1000 Nm

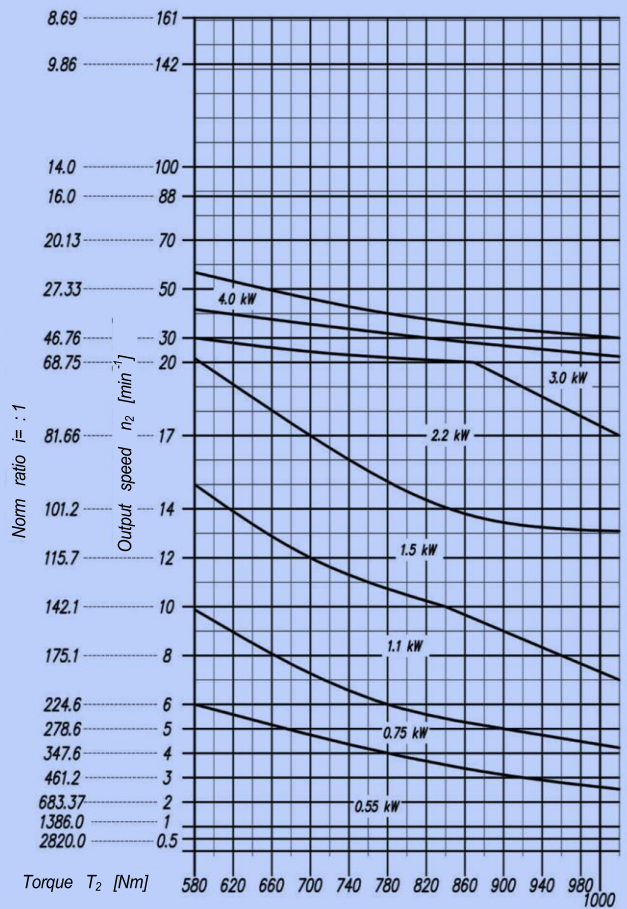

IEC - Standard 4-pole motor 1400 [min⁻¹]

80	0.55 kW	90	1.1 kW	100	2.2 kW	112	4.0 kW
80	0.75 kW	90	1.5 kW	100	3.0 kW		

Mounting types.

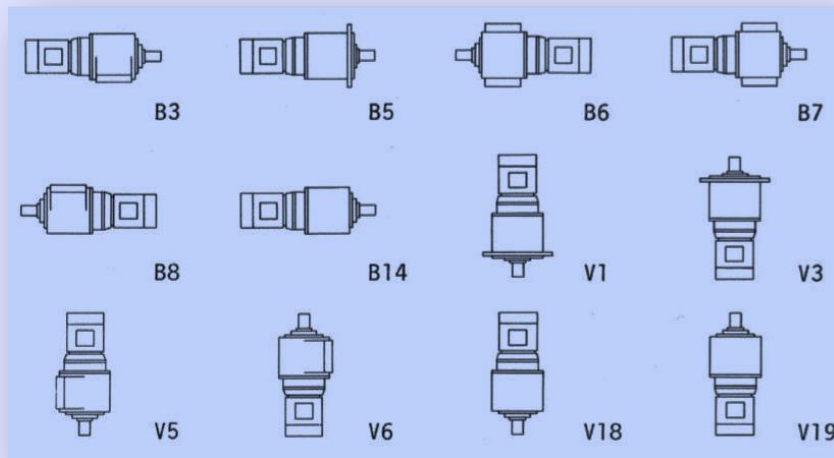

Drawings.

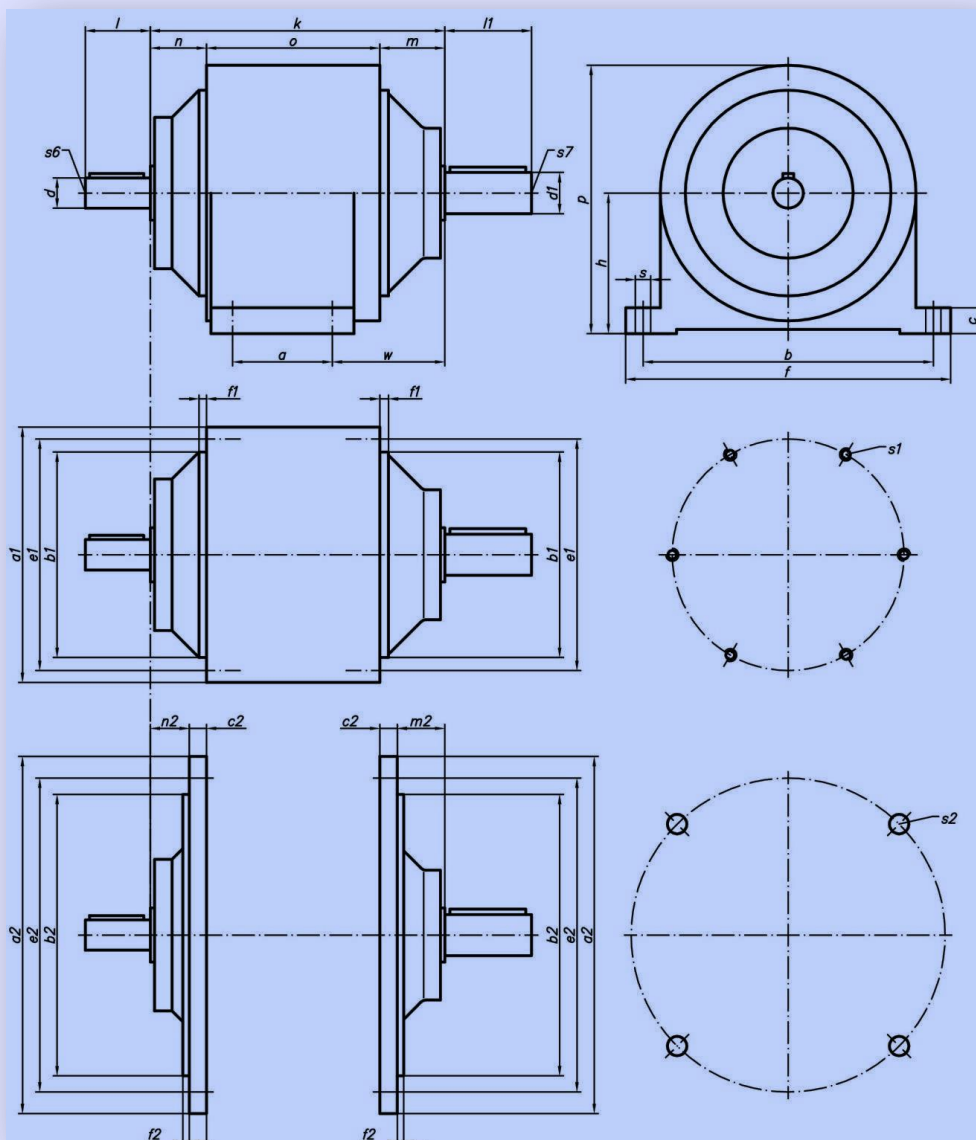

AKIM Gear technology – Swiss Made

Dimensions.

Type		11	81	121	12/451	251	501
Designs	Data	Dimensions					
B3, B6, B7, V5, V6	a	46	75	80	80	90	120
	b	134	190	214	214	250	300
	c	12	14	17	17	20	22
	f	150	215	246	246	280	330
	h	65	90	105	105	110	135
	k	136	165	188	188	210	269
	m	30	20	23	23	32	35
	n	26	20	23	23	32	35
	o	80	125	142	142	146	199
	p	124	172.5	197.5	197.5	216	265
	s	7	10.5	11	11	13	14
w	53	45	54	54	60	74.5	
B14, V18, V19	a1	118	165	185	185	212	260
	b1	95-k6	135-k6	140-k6	140-k6	270-k6	190-k6
	e1	107	150	170	170	195	240
	f1	4	3	4	4	4	3
	s1	4xM6x10	4xM6x20	8xM6x20	8xM6x20	4xM8x24	6xM8x24
B5, V1, V3	a2	165	230	250	250	280	320
	b2	130-k6	170-k6	185-k6	185-k6	220-k6	260-k6
	c2	8	10	12	12	15	15
	e2	145	200	215	215	250	290
	f2	3	3	4	4	4	5
	m2	22	10	11	11	17	15
	n2	18	10	11	11	17	15
	s2	4x9	4x11	4x11	4x11	4x14	4x14
Shaft end	d	14-k6	19-k6	24-k6	24-k6	28-k6	32-k6
	i	30	40	45	45	50	60
	d1	19-k6	24-k6	28-k6	32-k6	38-k6	55-k6
	l1	40	50	50	60	80	100
	s6	M4	M6	M6	M6	M8	M10
	s7	M6	M6	M8	M10	M10	M16

Permissible radial loads.

Type		11	81	121	12/451	251	501
Drive speed		Max. permissible radial load F_{r1} [N] related to the centre of the input shaft					
N ₁	800	400	600	800	800	1'200	1'430
	1000	370	560	740	740	1'100	1'330
	1250	340	520	670	670	1'020	1'230
	1600	320	480	630	630	940	1'140
	2000	290	440	590	590	870	
	2500	270	400	540	540		
	3200	250	380	500	500		
N ₂	10	2'320	3'880	5'870	11'800	15'900	19'500
	15	2'000	3'340	5'040	10'300	13'800	16'900
	25	1'710	2'860	4'330	8'980	12'000	14'700
	40	1'470	2'460	3'710	7'830	10'500	12'800
	65	1'260	2'100	3'180	6'830	9'180	11'200
	100	1'080	1'800	3'740	5'940	7'970	9'750
	125	1'000	1'670	3'530	5'540	7'440	9'110
	160	930	1'550	2'340	5'170	6'950	8'500
	200	860	1'430	2'170	4'830	6'480	7'930
	250	800	1'330	2'000	4'500	6'050	7'400

Backlash, rotation rigidity, mass moment of inertia.

Type		11	81	121	12/451	251	501
Normal Low backlash	Backlash at input shaft with nominal torque 0 Nm						
		1.2°	1.2°	1.3°	1.3°	1.3°	1.2°
		0.2°	0.3°	0.3°	0.3°	0.4°	0.4°
	Axial rigidity of output shaft						
		11'000	26'000	60'000	81'000	110'000	143'000
	Mass moment of inertia of input shaft [kgm ²]						
	0.0008	0.0015	0.0030	0.0060	0.0070	0.0084	

Motor mounting dimensions.

Type		11	81	121	12/451	251	501
Motor Type	Data	Motor mounting dimensions					
IEC-56 0.06/0.09 kW	a3	105					
	b3	70-E8					
	e3	85					
	d3	9-F7					
	n3	4					
	o3	33					
	s3	4x6.5					
IEC-63 0.12/0.18 kW	a3	120	140				
	b3	80-E8	95-E8				
	e3	100	115				
	d3	11-F7	11-F7				
	n3	4	3				
	o3	33	23				
	s3	4x6.5	4xM8				
IEC-71 0.25/0.37 kW	a3	105	160	160	160	160	
	b3	70-E8	110-H7	110-H7	110-H7	110-H7	
	e3	85	130	130	130	130	
	d3	14-F7	14-F7	14-F7	14-F7	14-F7	
	n3	4	4	3	3	6	
	o3	33	40	55	55	38	
	s3	4x6.5	4x8.5	4xM8	4xM8	4xM8	
IEC-80 0.55/0.75 kW	a3		160	200	200	200	200
	b3		110-H7	130-H7	130-H7	130-H7	130-H7
	e3		130	165	165	165	165
	d3		19-F7	19-F7	19-F7	19-F7	19-F7
	n3		4	3	3	10	4
	o3		40	83	83	60	45
	s3		4x8.5	4xM10	4xM10	4x11	4x11
IEC-90 1.1/1.5 kW	a3			200	200	200	200
	b3			130-H7	130-H7	130-H7	130-H7
	e3			165	165	165	165
	d3			24-F7	24-F7	24-F7	24-F7
	n3			3	3	10	4
	o3			83	83	60	45
	s3			4xM10	4xM10	4x11	4x11
IEC-100 2.2/3.0 kW	a3					200	200
	b3					130-H7	130-H7
	e3					165	165
	d3					28-F7	28-F7
	n3					10	4
	o3					60	45
	s3					4x11	4x11
IEC-112 4.0 kW	a3						200
	b3						130-H7
	e3						165
	d3						28-F7
	n3						4
	o3						45
	s3						4x11

